

Varenummer: 4395000281  
Beskrivelse: Rota-fix spændelement F28x55  
Rustfast stål

## Mål

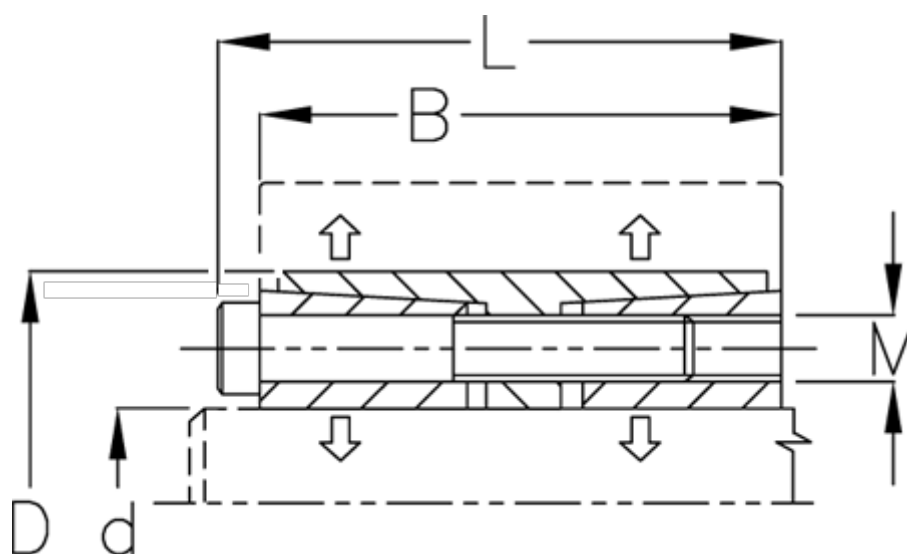

B mm	= 40
d H8 mm	= 28
D mm	= 55
F kN aksialkraft	= 35.4
L mm	= 46
M mm	= M6
Overfladeruhed	= R? ? 3.2 $\mu$ m
P N/mm <sup>2</sup> fladetryk på aksel/nav	= 34

T Nm drejningsmoment	= 490
Tolerance	= Aksel h8, Nav H8
Ts Nm boltetilspændingsmoment	= 11.8